

WORKBOOK

ENGLISH BUS

STARTER

1



Bricks

Welcome

A Trace and say.

The Alphabet

Aa Bb Cc Dd Ee

Ff Gg Hh Ii Jj

Kk Ll Mm Nn Oo

Pp Qq Rr Ss Tt

Uu Vv Ww

Xx Yy Zz



B Read, follow the paths, and act.

1.

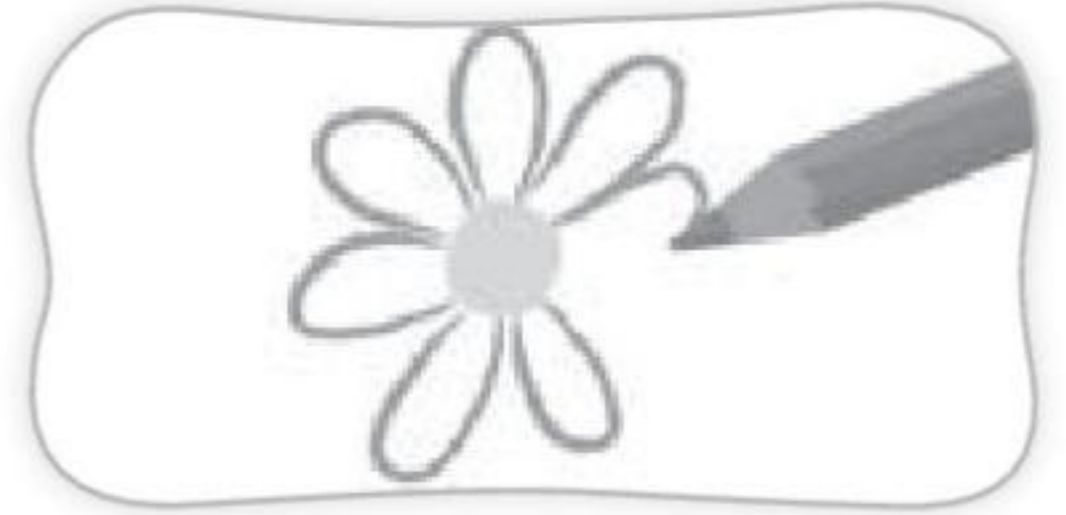

2.

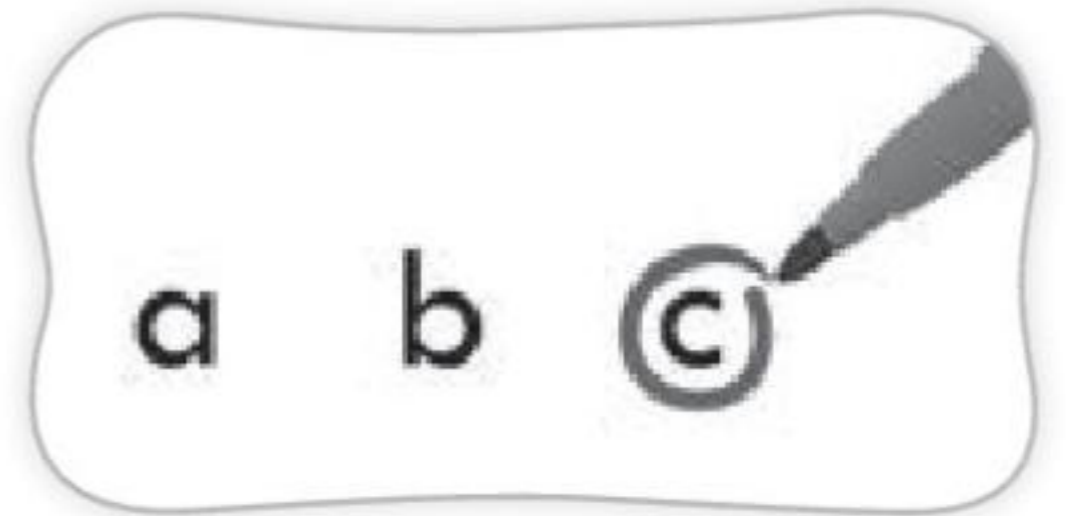
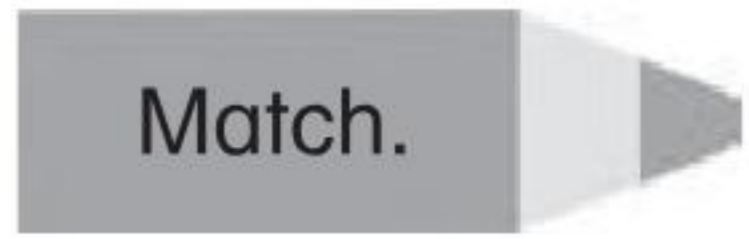

3.

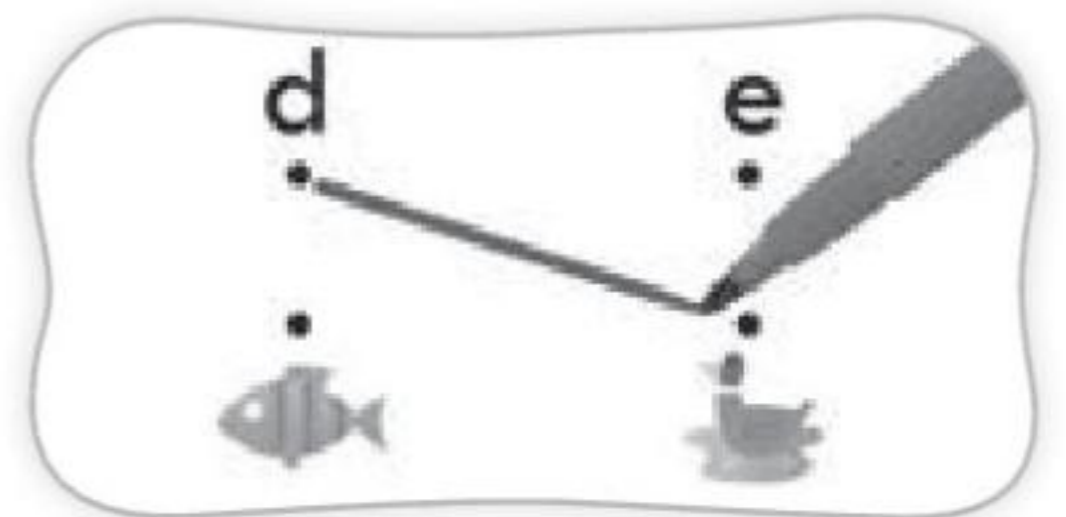
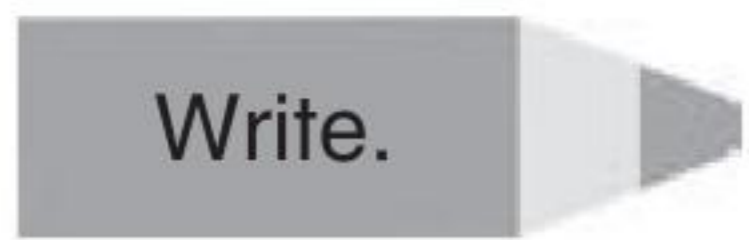

4.

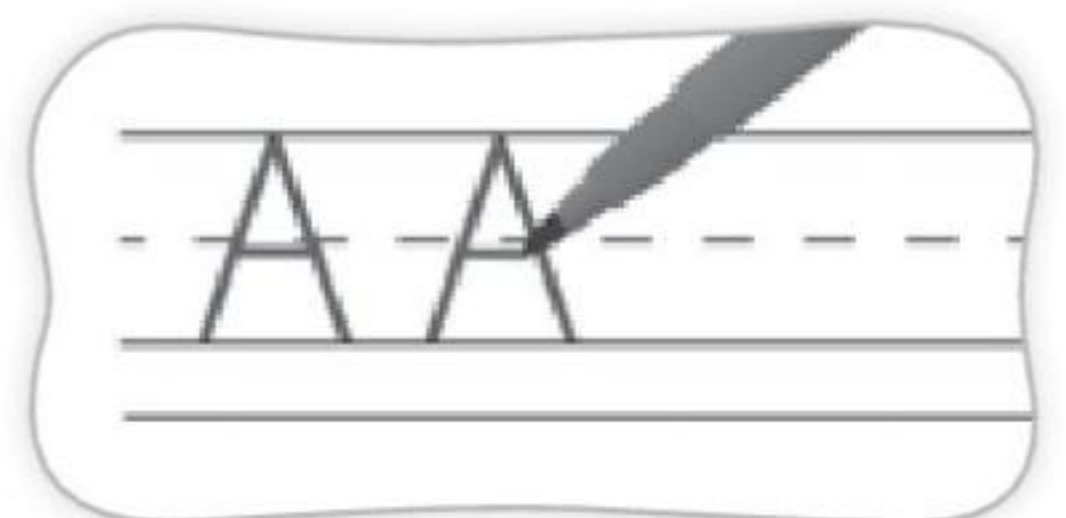
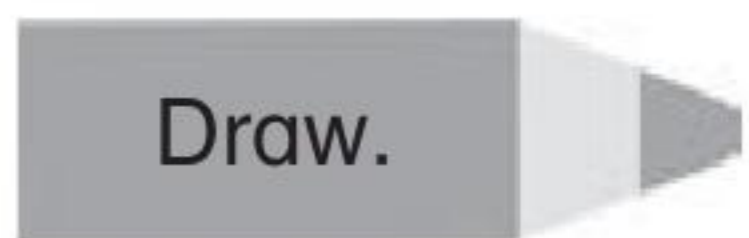



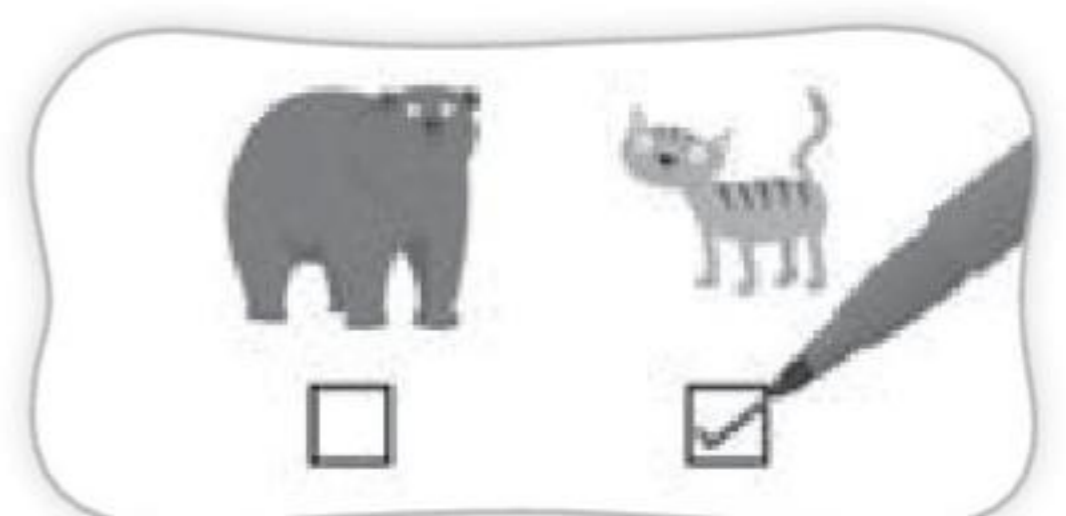
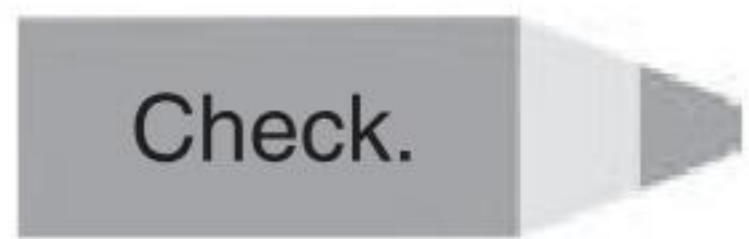







5.

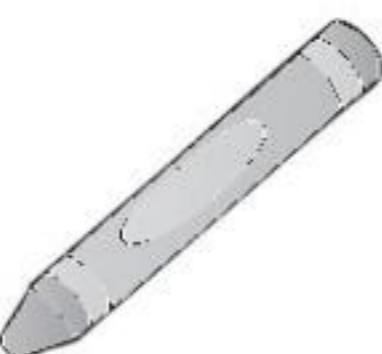









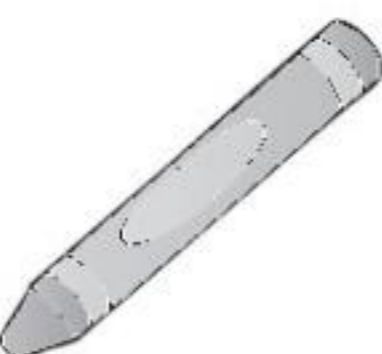



1 School Objects







START STREET







A Look and match.



1.           

2.       

3.      

4.      

5.      

6.  

● glue
● paper
● paint
● a pencil
● a crayon
● a pen

LEARN STREET 1

A Trace and match.

1.

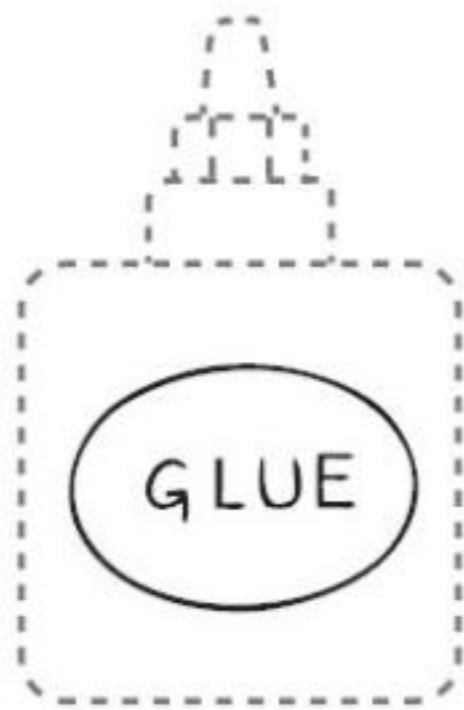

It's a pen.

2.

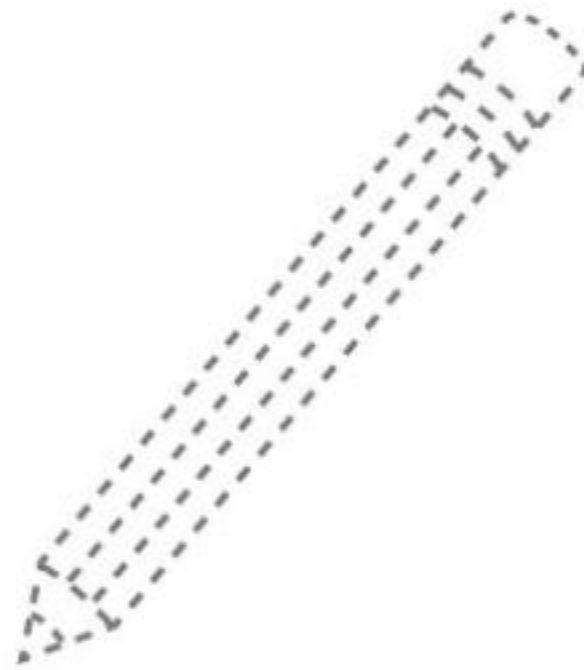

It's glue.

3.

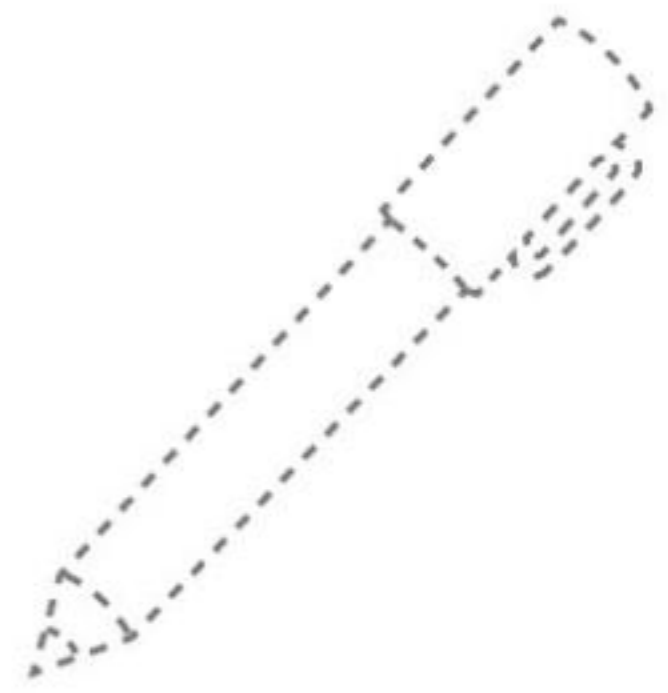

It's a pencil.

B Match and trace.

1.

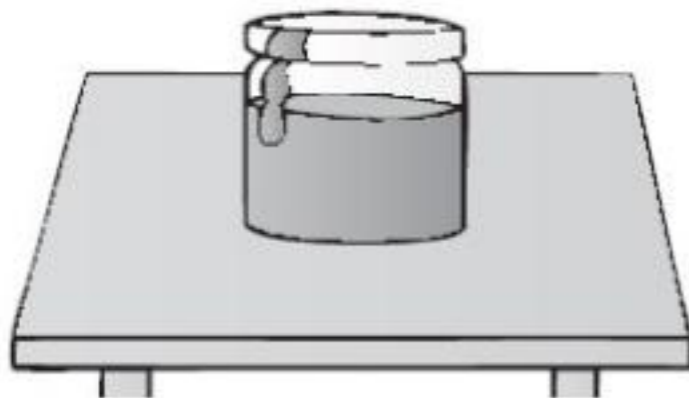

It's a crayon.

2.

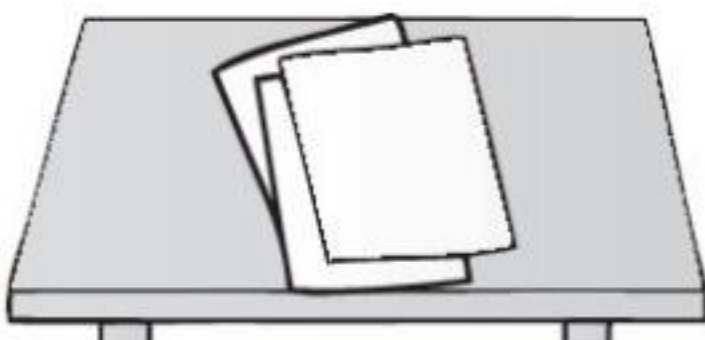

It's paper.

3.

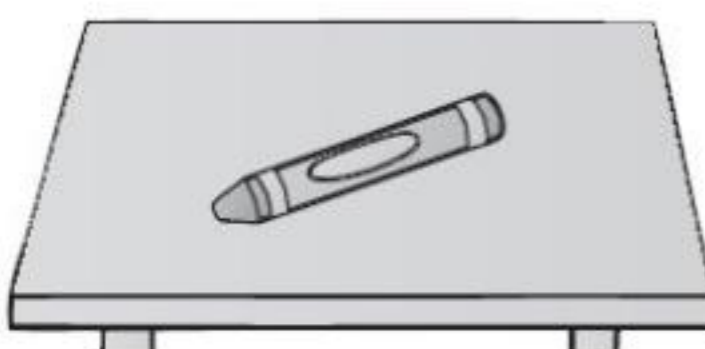

It's paint.

LEARN STREET 2

A Match and color.

1. a chair ●

2. a desk ●

3. a book ●

4. a bag ●

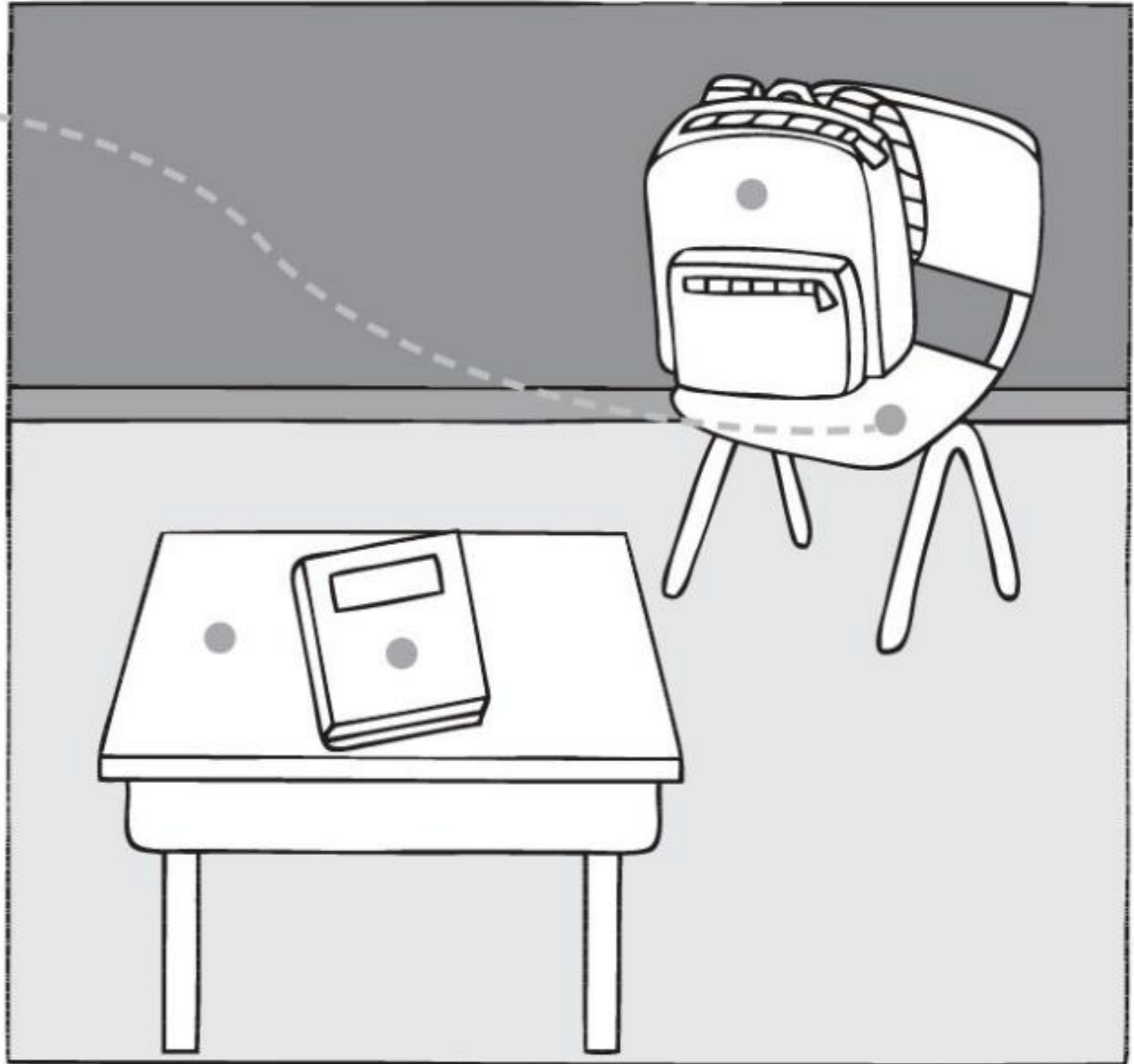

B Look and circle.

1.

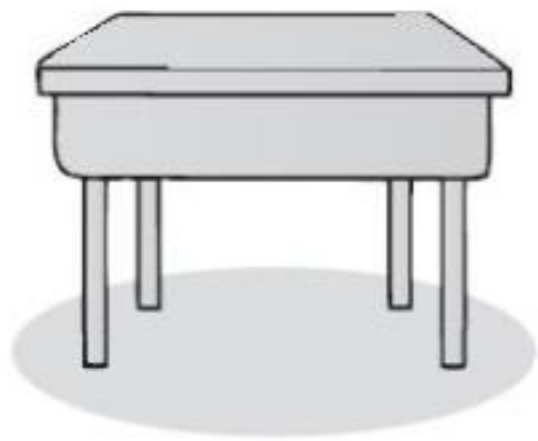

It's

a chair.

a desk.

2.



It's

a desk.

a bag.

3.



It's

a book.

a bag.

4.



It's

a book.

a chair.



C Look and match.

- 

What is it?

 - It's a chair.
- 

What is it?

 - It's a bag.
- 

What is it?

 - It's a book.

D Trace and say.

- What is it?

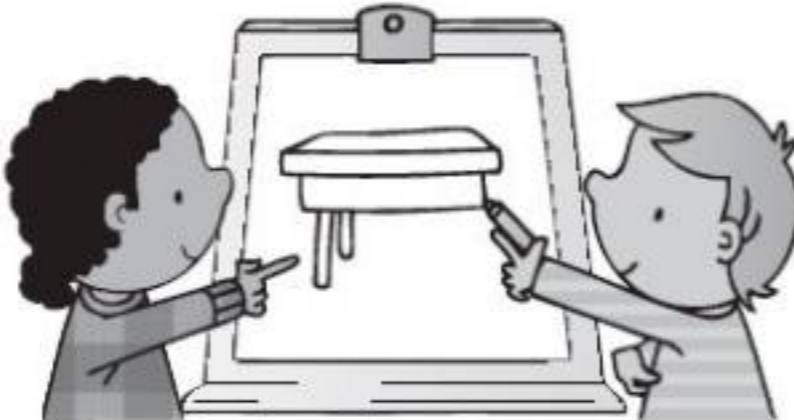

It's a desk.
- What is it?

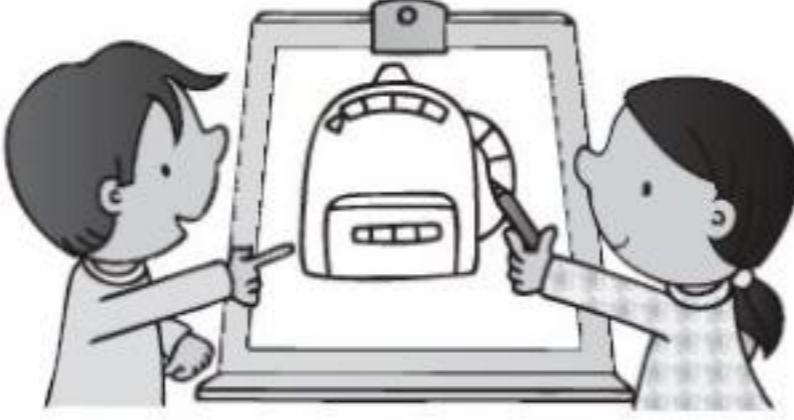

It's a bag.
- What is it?

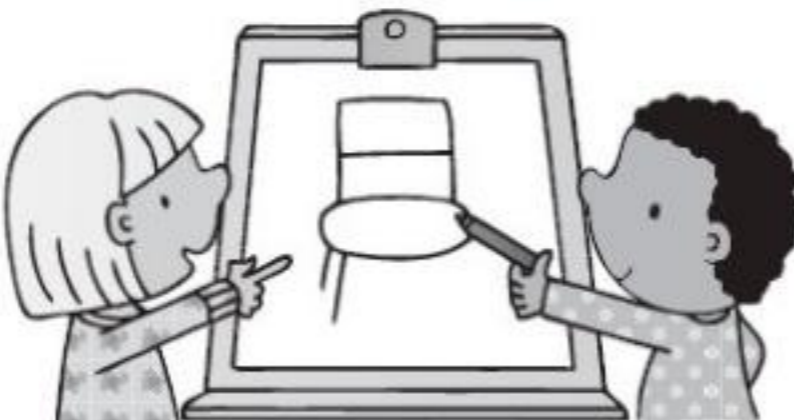

It's a chair.